

# 9 A!%&\$'8 7!A CHCF '7 CBHF C @9 F %&!&( J '%) 5

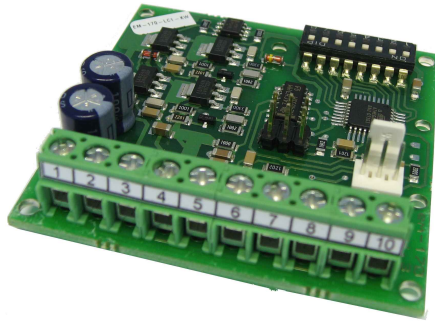

## FEATURES:

- 4-quadrants
- controlled direction change
- brake
- adjustable current limit
- acceleration and deceleration ramp
- dip-switch settable
- EMC-tested

EM-170 motor controller is designed for small DC-motors. The controller operates in 4-quadrants, in other words it is possible to drive the motor in variable speed, change motor running direction and brake. The power stage operates with PWM-principle and has thus high efficiency.

Speed set value is given as analog voltage signal. Motor voltage is fed back to controller, so changes in operating voltage will not affect motor running speed.

10V regulated auxillary voltage can be used for speed set potentiometer reference voltage. The acceleration speed can be adjusted with acceleration and deceleration ramp. Deceleration ramp can also be bypassed when rapid braking is desired. Additionally the unit is equipped with speed2-feature, which can be activated individually. This is especially practical in positioning applications. Current limit can be used to restrict motor torque and is dip-switch settable. Control inputs work with positive (NPN) logic. EM-170 is EMC-tested in accordance with industrial standards.

## TECHNICAL DATA:

Supply	12-35V
Current cons.	max 2A
Idle current	20mA
Output voltage	0-25V
Output current	1.5A continuous 2A (10s)
Current limit	0.2, 0.3, 0.4, 0.5, 0.6 0.7, 0.8, 0.9, 1, 1.1, 1.2 1.3, 1.4, 1.5, 1,7 and 2A
Ramp time	0, 0.1, 0.2, 0.3, 0.5 0.7, 1.0, 1.5s
Input control voltage	0-10V (Rin 100kohm)
ON/OFF control	0-1V ="off" 4-30V="on"
Input impedance	10kohm
Auxiliary voltage	10V (max. 5mA)
Operation freq.	16kHz
Operating temp.	0-60°C
EMC	EN-50081 and EN-50082-2
Measures	60x60x20mm
Weight	30g

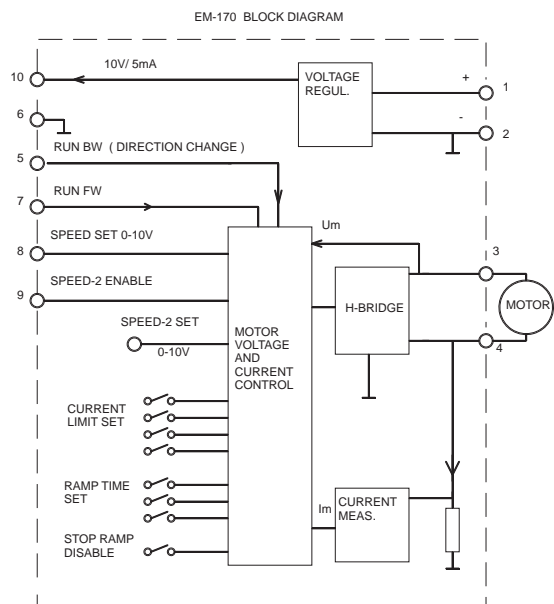

EM-170 OPERATING INSTRUCTIONS

Supply filtered 12-35VDC with ripple < 20% with full load.  
**CAUTION !** reverse polarity can damage the unit  
**CAUTION !** no internal fuse

SETTINGS AND CONNECTING UNIT

Switch off power before connecting motor and power supply to EM-170. Prepare the control circuit. Set current limit and ramp time according to application.

Control input value 0-10V correspond to motor output 0-25V, so with a supply of 12V 0-5V will output 0-12.5V.

Speed-2 set value is connected to molex-connector. Scale is the same as with speed-1. If speed-2 feature is not required, this potentiometer can simply be left out. Recommended speed control potentiometer value is 2.50kohm for both speed-1 and speed-2.

Control inputs can be used with switches, analog voltage or NPN outputs of a logic. A voltage signal greater than 4V is logic 1, maximum input voltage 30V. Forward input will start up the motor in forward direction. Reverse input will start up the motor in reverse direction. When motor is already running forward, direction will change. Speed-2 will set the running speed according to input signal in molex connector. Notice: Speed-2 input will start up the motor in forward direction even if no other inputs are activated.

Control voltage and speed set value are in reference with 0V gnd potential (pin6).

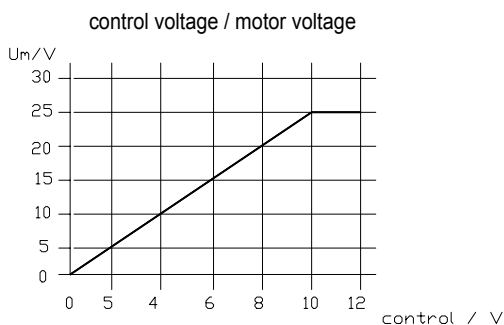

EXAMPLE 1

Speed set with potentiometer. Speed-2 set with external trimmer. Controls using switches.

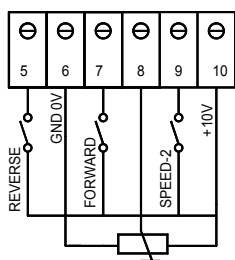

EXAMPLE 2

Speed set with voltage 0-10V. Speed-2 set with external trimmer. Controls using 4-30Vdc signal.

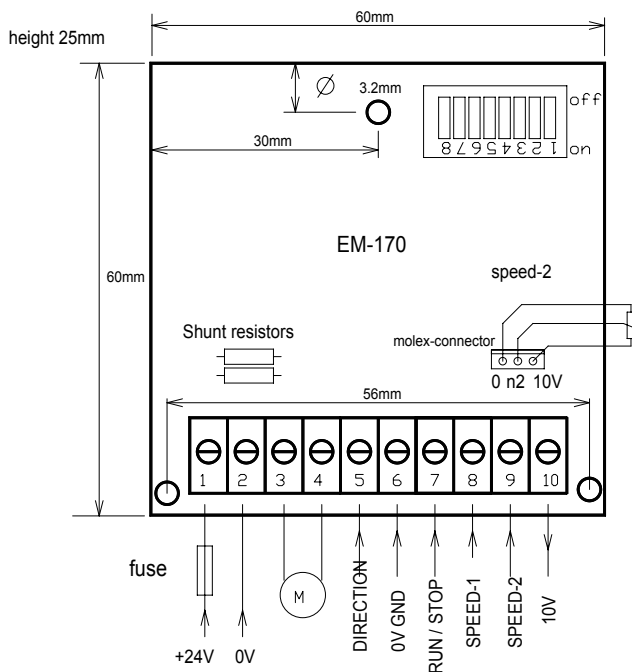
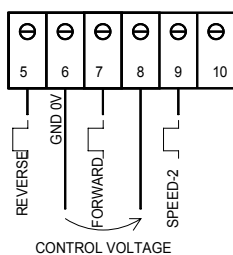

NOTE. With one shunt values will be halved.

current limit / A dip-switches 1-4

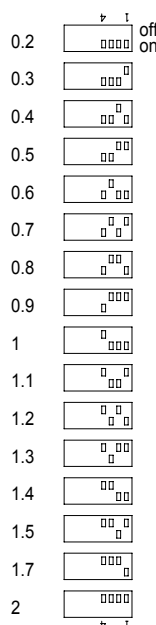

ramp time / s dip-switches 5-7

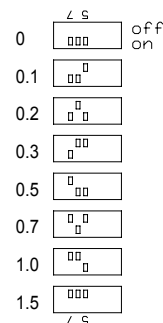

dip-switch 8

"off" = decel. ramp OFF  
 "on" = decel. ramp ON